



## Electric Counterbalance Trucks

# EG25 – EG35\*

Capacity 2.5 t – 3.5 t | Series 1276-02 | Linde Grey Line

ION

PB

### Versatile Load Mover

- The twin-motor front-wheel drive ensures maximum traction
- Perfectly suited for indoor applications due to its compact design
- Available with lead-acid or lithium-ion battery
- Ergonomic operator workplace with Linde Load Control

\*EG = Electric Grey Line | Cost-effective trucks for light- to medium-duty applications

# TECHNICAL DATA (according to VDI 2198)

|                 |                                 |                                                  |                                           |                         |                         |
|-----------------|---------------------------------|--------------------------------------------------|-------------------------------------------|-------------------------|-------------------------|
| Characteristics | 1.1                             | Manufacturer                                     |                                           | Linde MH                | Linde MH                |
|                 | 1.2                             | Manufacturer's type designation                  |                                           | EG25                    | EG30                    |
|                 | 1.2a                            | Series                                           |                                           | 1276-02                 | 1276-02                 |
|                 | 1.3                             | Power unit                                       |                                           | Battery                 | Battery                 |
|                 | 1.4                             | Operation                                        |                                           | Seat                    | Seat                    |
|                 | 1.5                             | Load capacity/Load                               | Q (t)                                     | 2.5                     | 3.0                     |
|                 | 1.6                             | Load centre distance                             | c (mm)                                    | 500                     | 500                     |
|                 | 1.8                             | Axle centre to fork face                         | x (mm)                                    | 447                     | 450                     |
|                 | 1.9                             | Wheelbase                                        | y (mm)                                    | 1780                    | 1780                    |
| Weights         | 2.1                             | Service weight                                   | kg                                        | 4593 <sup>1)</sup>      | 4834 <sup>1)</sup>      |
|                 | 2.2                             | Axle load with load, front/rear                  | kg                                        | 6170/923                | 6978/856                |
|                 | 2.3                             | Axle load without load, front/rear               | kg                                        | 2340/2253 <sup>1)</sup> | 2377/2457 <sup>1)</sup> |
| Wheels/Tyres    | 3.1                             | Tyres rubber, SE, pneumatic, polyurethane        |                                           | SE                      | SE                      |
|                 | 3.2                             | Tyre size, front                                 |                                           | 225/75-10 (23x9-10)     | 250/60-12 (23x10-12)    |
|                 | 3.3                             | Tyre size, rear                                  |                                           | 200/50-10               | 200/50-10               |
|                 | 3.5                             | Wheels, number front/rear (x = driven)           |                                           | 2x/2                    | 2x/2                    |
|                 | 3.6                             | Track width, front                               | b10 (mm)                                  | 950                     | 980                     |
|                 | 3.7                             | Track width, rear                                | b11 (mm)                                  | 932                     | 932                     |
|                 | Dimensions                      | 4.1                                              | Mast/fork carriage tilt, forward/backward | $\alpha/\beta$ (°)      | 5.0/7.5                 |
| 4.2             |                                 | Height of mast, lowered                          | h1 (mm)                                   | 2241                    | 2241                    |
| 4.3             |                                 | Free lift                                        | h2 (mm)                                   | 150                     | 150                     |
| 4.4             |                                 | Lift                                             | h3 (mm)                                   | 3195                    | 3195                    |
| 4.5             |                                 | Height of mast, extended                         | h4 (mm)                                   | 3978                    | 3981                    |
| 4.7             |                                 | Height of overhead guard (cabin)                 | h6 (mm)                                   | 2085                    | 2085                    |
| 4.8             |                                 | Seat height relating to SIP/stand height         | h7 (mm)                                   | 1134                    | 1134                    |
| 4.12            |                                 | Towing coupling height                           | h10 (mm)                                  | 654                     | 654                     |
| 4.19            |                                 | Overall length                                   | l1 (mm)                                   | 3500                    | 3503                    |
| 4.20            |                                 | Length to fork face                              | l2 (mm)                                   | 2500                    | 2503                    |
| 4.21            |                                 | Overall width                                    | b1/b2 (mm)                                | 1175                    | 1228                    |
| 4.22            |                                 | Fork dimensions DIN ISO 2331                     | s/e/l (mm)                                | 45 × 100 × 1000         | 45 × 100 × 1000         |
| 4.23            |                                 | Fork carriage to ISO 2328, class/type A, B       |                                           | 2A                      | 3A                      |
| 4.24            |                                 | Width of fork carriage                           | b3 (mm)                                   | 1150                    | 1150                    |
| 4.31            |                                 | Ground clearance, below mast                     | m1 (mm)                                   | 138                     | 137                     |
| 4.32            |                                 | Ground clearance, centre of wheelbase            | m2 (mm)                                   | 122                     | 122                     |
| 4.34.1          |                                 | Aisle width for pallets 1000 × 1200 crossways    | Ast (mm)                                  | 3902 <sup>2)</sup>      | 3905 <sup>2)</sup>      |
| 4.34.2          |                                 | Aisle width with pallet 800 × 1200 along forks   | Ast (mm)                                  | 4102 <sup>2)</sup>      | 4105 <sup>2)</sup>      |
| 4.35            |                                 | Turning radius                                   | Wa (mm)                                   | 2255                    | 2255                    |
| 4.36            | Minimum pivoting point distance | b13 (mm)                                         | 636                                       | 636                     |                         |
| Performance     | 5.1                             | Travel speed, with/without load                  | km/h                                      | 20/20                   | 20/20                   |
|                 | 5.1.1                           | Travel speed, with/without load, backwards       | km/h                                      | 20/20                   | 20/20                   |
|                 | 5.2                             | Lifting speed, with/without load                 | m/s                                       | 0.44/0.51               | 0.42/0.51               |
|                 | 5.3                             | Lowering speed, with/without load                | m/s                                       | 0.56/0.56               | 0.56/0.56               |
|                 | 5.5                             | Tractive force, with/without load                | N                                         | 5550/6500               | 5150/6600               |
|                 | 5.6                             | Maximum tractive force, with/without load        | N                                         | 14300/13760             | 14200/13860             |
|                 | 5.7                             | Climbing ability, with/without load              | %                                         | 8.0/15.0                | 7.0/14.0                |
|                 | 5.8                             | Maximum climbing ability, with/without load      | %                                         | 21.0/30.0               | 18.0/29.0               |
|                 | 5.9                             | Acceleration time, with/without load             | s                                         | 6.3/6.1                 | 6.5/6.0                 |
|                 | 5.10                            | Service brake                                    |                                           | electric/mechanical     | electric/mechanical     |
| Drive           | 6.1                             | Drive motor rating S2 60 min                     | kW                                        | 2x 9                    | 2x 9                    |
|                 | 6.2                             | Lift motor rating at S3 15%                      | kW                                        | 17                      | 17                      |
|                 | 6.3                             | Battery according to DIN 43531/35/36 A,B,C,no    |                                           | 43 536 A                | 43 536 A                |
|                 | 6.4                             | Battery voltage/rated capacity (5h)              | (V)/(Ah) o. kWh                           | 80/575                  | 80/575                  |
|                 | 6.4.a                           | Battery energy content                           | kWh                                       | 36.8                    | 36.8                    |
|                 | 6.5                             | Battery weight (±5%)                             | kg                                        | 1458                    | 1458                    |
|                 | 6.6                             | Energy consumption according to DIN EN 16796     | kWh/h                                     | 5.9                     | 6                       |
| Others          | 10.1                            | Operating pressure for attachments               | bar                                       | 185                     | 210                     |
|                 | 10.2                            | Oil flow for attachments                         | l/min                                     | 32                      | 32                      |
|                 | 10.7                            | Sound pressure level LpAZ (at the driver's seat) | dB(A)                                     | 70                      | 70                      |
|                 | 11.2                            | Static stability                                 |                                           | 1.69                    | 1.53                    |

1) Figures with battery, see line 6.4/6.5.

2) Including a 200 mm (min.) operating aisle clearance.

# TECHNICAL DATA (according to VDI 2198)

|                 |                                    |                                                  |                                           |                         |                         |                         |
|-----------------|------------------------------------|--------------------------------------------------|-------------------------------------------|-------------------------|-------------------------|-------------------------|
| Characteristics | 1.1                                | Manufacturer                                     |                                           | Linde MH                | Linde MH                | Linde MH                |
|                 | 1.2                                | Manufacturer's type designation                  |                                           | EG25 H                  | EG30 H                  | EG35 H                  |
|                 | 1.2a                               | Series                                           |                                           | 1276-02                 | 1276-02                 | 1276-02                 |
|                 | 1.3                                | Power unit                                       |                                           | Battery                 | Battery                 | Battery                 |
|                 | 1.4                                | Operation                                        |                                           | Seat                    | Seat                    | Seat                    |
|                 | 1.5                                | Load capacity/Load                               | Q (t)                                     | 2.5                     | 3.0                     | 3.5                     |
|                 | 1.6                                | Load centre distance                             | c (mm)                                    | 500                     | 500                     | 500                     |
|                 | 1.8                                | Axle centre to fork face                         | x (mm)                                    | 447                     | 450                     | 455                     |
|                 | 1.9                                | Wheelbase                                        | y (mm)                                    | 1780                    | 1780                    | 1780                    |
| Weights         | 2.1                                | Service weight                                   | kg                                        | 5092 <sup>1)</sup>      | 5310 <sup>1)</sup>      | 5673 <sup>1)</sup>      |
|                 | 2.2                                | Axle load with load, front/rear                  | kg                                        | 6379/1213               | 7175/1135               | 8016/1157               |
|                 | 2.3                                | Axle load without load, front/rear               | kg                                        | 2549/2543 <sup>1)</sup> | 2574/2736 <sup>1)</sup> | 2638/3035 <sup>1)</sup> |
| Wheels/Tyres    | 3.1                                | Tyres rubber, SE, pneumatic, polyurethane        |                                           | SE                      | SE                      | SE                      |
|                 | 3.2                                | Tyre size, front                                 |                                           | 225/75-10 (23x9-10)     | 250/60-12 (23x10-12)    | 315/45-12               |
|                 | 3.3                                | Tyre size, rear                                  |                                           | 200/50-10               | 200/50-10               | 200/50-10               |
|                 | 3.5                                | Wheels, number front/rear (x = driven)           |                                           | 2x/2                    | 2x/2                    | 2x/2                    |
|                 | 3.6                                | Track width, front                               | b10 (mm)                                  | 950                     | 980                     | 1,030                   |
|                 | 3.7                                | Track width, rear                                | b11 (mm)                                  | 932                     | 932                     | 932                     |
|                 | Dimensions                         | 4.1                                              | Mast/fork carriage tilt, forward/backward | $\alpha/\beta$ (°)      | 5.0/7.5                 | 5.0/7.5                 |
| 4.2             |                                    | Height of mast, lowered                          | h1 (mm)                                   | 2241                    | 2241                    | 2241                    |
| 4.3             |                                    | Free lift                                        | h2 (mm)                                   | 150                     | 150                     | 150                     |
| 4.4             |                                    | Lift                                             | h3 (mm)                                   | 3195                    | 3195                    | 3195                    |
| 4.5             |                                    | Height of mast, extended                         | h4 (mm)                                   | 3978                    | 3981                    | 3981                    |
| 4.7             |                                    | Height of overhead guard (cabin)                 | h6 (mm)                                   | 2242                    | 2242                    | 2242                    |
| 4.8             |                                    | Seat height relating to SIP/stand height         | h7 (mm)                                   | 1291                    | 1291                    | 1291                    |
| 4.12            |                                    | Towing coupling height                           | h10 (mm)                                  | 674                     | 674                     | 674                     |
| 4.19            |                                    | Overall length                                   | l1 (mm)                                   | 3500                    | 3503                    | 3508                    |
| 4.20            |                                    | Length to fork face                              | l2 (mm)                                   | 2500                    | 2503                    | 2508                    |
| 4.21            |                                    | Overall width                                    | b1/b2 (mm)                                | 1175                    | 1228                    | 1325                    |
| 4.22            |                                    | Fork dimensions DIN ISO 2331                     | s/e/l (mm)                                | 45 × 100 × 1000         | 45 × 100 × v 1000       | 50 × 120 × 1000         |
| 4.23            |                                    | Fork carriage to ISO 2328, class/type A, B       |                                           | 2A                      | 3A                      | 3A                      |
| 4.24            |                                    | Width of fork carriage                           | b3 (mm)                                   | 1150                    | 1150                    | 1150                    |
| 4.31            |                                    | Ground clearance, below mast                     | m1 (mm)                                   | 138                     | 137                     | 137                     |
| 4.32            |                                    | Ground clearance, centre of wheelbase            | m2 (mm)                                   | 122                     | 122                     | 122                     |
| 4.34.1          |                                    | Aisle width for pallets 1000 × 1200 crossways    | Ast (mm)                                  | 3902 <sup>2)</sup>      | 3905 <sup>2)</sup>      | 3910 <sup>2)</sup>      |
| 4.34.2          |                                    | Aisle width with pallet 800 × 1200 along forks   | Ast (mm)                                  | 4102 <sup>2)</sup>      | 4105 <sup>2)</sup>      | 4110 <sup>2)</sup>      |
| 4.35            |                                    | Turning radius                                   | Wa (mm)                                   | 2255                    | 2255                    | 2255                    |
| 4.36            | Minimum pivoting point distance    | b13 (mm)                                         | 636                                       | 636                     | 636                     |                         |
| Performance     | 5.1                                | Travel speed, with/without load                  | km/h                                      | 20/20                   | 20/20                   | 20/20                   |
|                 | 5.1.1                              | Travel speed, with/without load, backwards       | km/h                                      | 20/20                   | 20/20                   | 20/20                   |
|                 | 5.2                                | Lifting speed, with/without load                 | m/s                                       | 0.44/0.51               | 0.42/0.51               | 0.39/0.51               |
|                 | 5.3                                | Lowering speed, with/without load                | m/s                                       | 0.56/0.56               | 0.56/0.56               | 0.56/0.56               |
|                 | 5.5                                | Tractive force, with/without load                | N                                         | 6650/7300               | 6200/6500               | 5500/5900               |
|                 | 5.6                                | Maximum tractive force, with/without load        | N                                         | 14800/14800             | 14800/14800             | 15200/15200             |
|                 | 5.7                                | Climbing ability, with/without load              | %                                         | 9.0/15.0                | 8.0/13.0                | 6.0/11.0                |
|                 | 5.8                                | Maximum climbing ability, with/without load      | %                                         | 20.0/29.0               | 18.0/28.0               | 17.0/27.0               |
|                 | 5.9                                | Acceleration time, with/without load             | s                                         | 6.3/6.1                 | 6.2/5.9                 | 6.3/6.1                 |
|                 | 5.10                               | Service brake                                    |                                           | electric/mechanical     | electric/mechanical     | electric/mechanical     |
| Drive           | 6.1                                | Drive motor rating S2 60 min                     | kW                                        | 2x 9                    | 2x 9                    | 2x 9                    |
|                 | 6.2                                | Lift motor rating at S3 15%                      | kW                                        | 17                      | 17                      | 17                      |
|                 | 6.3                                | Battery according to DIN 43531/35/36 A,B,C,no    |                                           | 43 536 A                | 43 536 A                | 43 536 A                |
|                 | 6.4                                | Battery voltage/rated capacity (5h)              | (V)/(Ah) o. kWh                           | 80/700                  | 80/700                  | 80/700                  |
|                 | 6.4.a                              | Battery energy content                           | kWh                                       | 44.8                    | 44.8                    | 44.8                    |
|                 | 6.5                                | Battery weight (±5%)                             | kg                                        | 1863                    | 1863                    | 1863                    |
|                 | 6.6                                | Energy consumption according to DIN EN 16796     | kWh/h                                     | 6.1                     | 6.6                     | 7                       |
| 10.1            | Operating pressure for attachments | bar                                              | 185                                       | 210                     | 230                     |                         |
| Others          | 10.2                               | Oil flow for attachments                         | l/min                                     | 32                      | 32                      | 32                      |
|                 | 10.7                               | Sound pressure level LpAZ (at the driver's seat) | dB(A)                                     | 70                      | 70                      | 70                      |
|                 | 11.2                               | Static stability                                 |                                           | 1.91                    | 1.71                    | 1.62                    |

1) Figures with battery, see line 6.4/6.5.

2) Including a 200 mm (min.) operating aisle clearance.

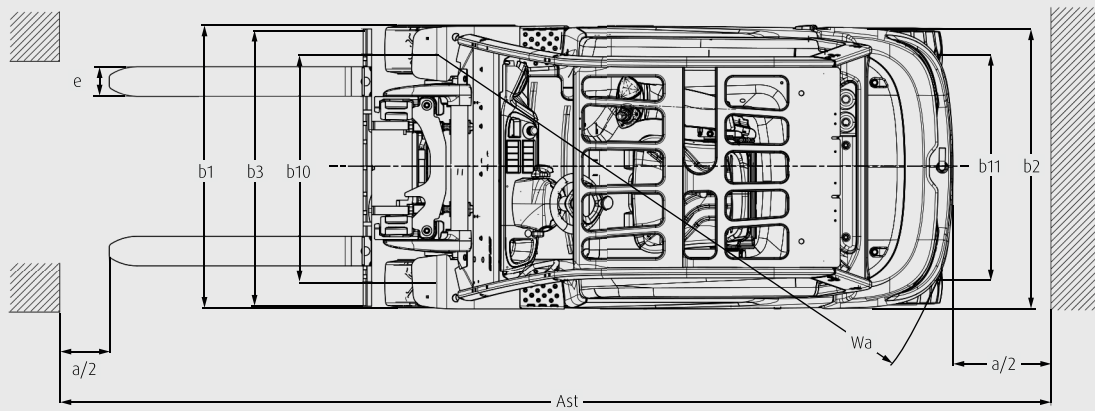
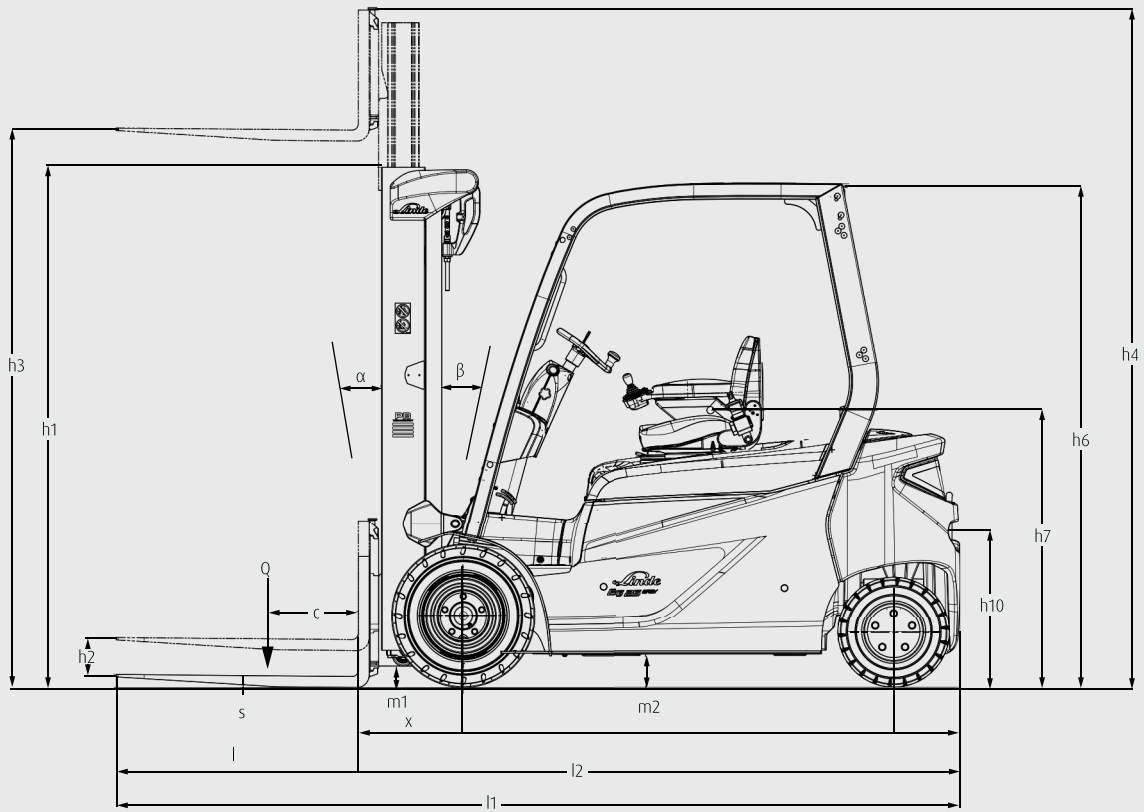

# MAST TABLES

## STANDARD MAST (in mm)

| Series                                 | 1512                         |                              |                              |                              |                              |                              |
|----------------------------------------|------------------------------|------------------------------|------------------------------|------------------------------|------------------------------|------------------------------|
| Lift                                   | h3: 2995                     | h3: 3195                     | h3: 3295                     | h3: 3495                     | h3: 3695                     | h3: 3995                     |
| <b>Height measurements</b>             | h1: 2179 h2: 150<br>h4: 3781 | h1: 2297 h2: 150<br>h4: 3981 | h1: 2347 h2: 150<br>h4: 4081 | h1: 2447 h2: 150<br>h4: 4281 | h1: 2547 h2: 150<br>h4: 4481 | h1: 2697 h2: 150<br>h4: 4781 |
| <b>Manufacturer's type designation</b> |                              |                              |                              |                              |                              |                              |
| EG25                                   | <input type="checkbox"/>     | <input type="checkbox"/>     | <input type="checkbox"/>     | <input type="checkbox"/>     | <input type="checkbox"/>     | <input type="checkbox"/>     |
| EG30                                   | <input type="checkbox"/>     | <input type="checkbox"/>     | <input type="checkbox"/>     | <input type="checkbox"/>     | <input type="checkbox"/>     | <input type="checkbox"/>     |
| EG25 H                                 | <input type="checkbox"/>     | <input type="checkbox"/>     | <input type="checkbox"/>     | <input type="checkbox"/>     | <input type="checkbox"/>     | <input type="checkbox"/>     |
| EG30 H                                 | <input type="checkbox"/>     | <input type="checkbox"/>     | <input type="checkbox"/>     | <input type="checkbox"/>     | <input type="checkbox"/>     | <input type="checkbox"/>     |
| EG35 H                                 | <input type="checkbox"/>     | <input type="checkbox"/>     | <input type="checkbox"/>     | <input type="checkbox"/>     | <input type="checkbox"/>     | <input type="checkbox"/>     |

| Series                                 | 1512                         |                              |                              |
|----------------------------------------|------------------------------|------------------------------|------------------------------|
| Lift                                   | h3: 4095                     | h3: 4495                     | h3: 4995                     |
| <b>Height measurements</b>             | h1: 2747 h2: 150<br>h4: 4881 | h1: 2947 h2: 150<br>h4: 5281 | h1: 3197 h2: 150<br>h4: 5781 |
| <b>Manufacturer's type designation</b> |                              |                              |                              |
| EG25                                   | <input type="checkbox"/>     | <input type="checkbox"/>     | <input type="checkbox"/>     |
| EG30                                   | <input type="checkbox"/>     | <input type="checkbox"/>     | <input type="checkbox"/>     |
| EG25 H                                 | <input type="checkbox"/>     | <input type="checkbox"/>     | <input type="checkbox"/>     |
| EG30 H                                 | <input type="checkbox"/>     | <input type="checkbox"/>     | <input type="checkbox"/>     |
| EG35 H                                 | <input type="checkbox"/>     | <input type="checkbox"/>     | <input type="checkbox"/>     |

## DUPLEX MAST (in mm)

| Series                                 | 1512                          |                               |                               |                               |                               |
|----------------------------------------|-------------------------------|-------------------------------|-------------------------------|-------------------------------|-------------------------------|
| Lift                                   | h3: 2965                      | h3: 3265                      | h3: 3765                      | h3: 4065                      | h3: 4565                      |
| <b>Height measurements</b>             | h1: 2102 h2: 1293<br>h4: 3750 | h1: 2252 h2: 1443<br>h4: 4050 | h1: 2502 h2: 1693<br>h4: 4550 | h1: 2652 h2: 1843<br>h4: 4850 | h1: 2902 h2: 2093<br>h4: 5350 |
| <b>Manufacturer's type designation</b> |                               |                               |                               |                               |                               |
| EG25                                   | <input type="checkbox"/>      | <input type="checkbox"/>      | <input type="checkbox"/>      | <input type="checkbox"/>      | <input type="checkbox"/>      |
| EG30                                   | <input type="checkbox"/>      | <input type="checkbox"/>      | <input type="checkbox"/>      | <input type="checkbox"/>      | <input type="checkbox"/>      |
| EG25 H                                 | <input type="checkbox"/>      | <input type="checkbox"/>      | <input type="checkbox"/>      | <input type="checkbox"/>      | <input type="checkbox"/>      |
| EG30 H                                 | <input type="checkbox"/>      | <input type="checkbox"/>      | <input type="checkbox"/>      | <input type="checkbox"/>      | <input type="checkbox"/>      |
| EG35 H                                 | <input type="checkbox"/>      | <input type="checkbox"/>      | <input type="checkbox"/>      | <input type="checkbox"/>      | <input type="checkbox"/>      |

## TRIPLEX MAST (in mm)

| Series                                 | 1512                          |                               |                               |                               |                               |                               |
|----------------------------------------|-------------------------------|-------------------------------|-------------------------------|-------------------------------|-------------------------------|-------------------------------|
| Lift                                   | h3: 4380                      | h3: 4680                      | h3: 4830                      | h3: 4980                      | h3: 5330                      | h3: 5480                      |
| <b>Height measurements</b>             | h1: 2102 h2: 1293<br>h4: 5143 | h1: 2202 h2: 1393<br>h4: 5443 | h1: 2252 h2: 1443<br>h4: 5593 | h1: 2302 h2: 1493<br>h4: 5743 | h1: 2452 h2: 1643<br>h4: 6093 | h1: 2502 h2: 1693<br>h4: 6243 |
| <b>Manufacturer's type designation</b> |                               |                               |                               |                               |                               |                               |
| EG25                                   | <input type="checkbox"/>      | <input type="checkbox"/>      | <input type="checkbox"/>      | <input type="checkbox"/>      | <input type="checkbox"/>      | <input type="checkbox"/>      |
| EG30                                   | <input type="checkbox"/>      | <input type="checkbox"/>      | <input type="checkbox"/>      | <input type="checkbox"/>      | <input type="checkbox"/>      | <input type="checkbox"/>      |
| EG25 H                                 | <input type="checkbox"/>      | <input type="checkbox"/>      | <input type="checkbox"/>      | <input type="checkbox"/>      | <input type="checkbox"/>      | <input type="checkbox"/>      |
| EG30 H                                 | <input type="checkbox"/>      | <input type="checkbox"/>      | <input type="checkbox"/>      | <input type="checkbox"/>      | <input type="checkbox"/>      | <input type="checkbox"/>      |
| EG35 H                                 | <input type="checkbox"/>      | <input type="checkbox"/>      | <input type="checkbox"/>      | <input type="checkbox"/>      | <input type="checkbox"/>      | <input type="checkbox"/>      |

| Series                                 | 1512                          |                               |                               |
|----------------------------------------|-------------------------------|-------------------------------|-------------------------------|
| Lift                                   | h3: 5930                      | h3: 6430                      | h3: 6580                      |
| <b>Height measurements</b>             | h1: 2652 h2: 1843<br>h4: 6693 | h1: 2852 h2: 2043<br>h4: 7193 | h1: 2902 h2: 2093<br>h4: 7343 |
| <b>Manufacturer's type designation</b> |                               |                               |                               |
| EG25                                   | <input type="checkbox"/>      | <input type="checkbox"/>      | <input type="checkbox"/>      |
| EG30                                   | <input type="checkbox"/>      | <input type="checkbox"/>      | <input type="checkbox"/>      |
| EG25 H                                 | <input type="checkbox"/>      | <input type="checkbox"/>      | <input type="checkbox"/>      |
| EG30 H                                 | <input type="checkbox"/>      | <input type="checkbox"/>      | <input type="checkbox"/>      |
| EG35 H                                 | <input type="checkbox"/>      | <input type="checkbox"/>      | <input type="checkbox"/>      |

○ Optional equipment

**h1:** Height of mast, lowered

**h2:** Free lift

**h3:** Lift

**h4:** Height of mast, extended

# LOAD CAPACITY

## EG25

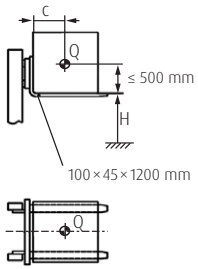

| H (mm)        | Q (kg)    |      |      |      |  |
|---------------|-----------|------|------|------|--|
| 6000          | 1870      | 1690 | 1540 | 1420 |  |
| 5900          | 1940      | 1760 | 1600 | 1470 |  |
| 5800          | 2020      | 1830 | 1670 | 1530 |  |
| 5700          | 2100      | 1900 | 1730 | 1590 |  |
| 5600          | 2180      | 1970 | 1800 | 1650 |  |
| 5500          | 2260      | 2040 | 1860 | 1710 |  |
| 5400          | 2340      | 2110 | 1930 | 1770 |  |
| 5300          | 2420      | 2180 | 1990 | 1830 |  |
| ≤ 5200        | 2500      | 2260 | 2060 | 1890 |  |
| <b>c (mm)</b> | 400 - 500 | 600  | 700  | 800  |  |

## EG25 H

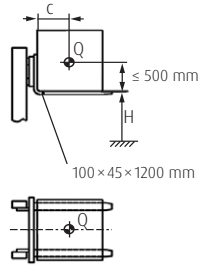

| H (mm)        | Q (kg)    |      |      |      |  |
|---------------|-----------|------|------|------|--|
| 6000          | 1870      | 1690 | 1540 | 1420 |  |
| 5900          | 1940      | 1760 | 1600 | 1470 |  |
| 5800          | 2020      | 1830 | 1670 | 1530 |  |
| 5700          | 2100      | 1900 | 1730 | 1590 |  |
| 5600          | 2180      | 1970 | 1800 | 1650 |  |
| 5500          | 2260      | 2040 | 1860 | 1710 |  |
| 5400          | 2340      | 2110 | 1930 | 1770 |  |
| 5300          | 2420      | 2180 | 1990 | 1830 |  |
| ≤ 5200        | 2500      | 2260 | 2060 | 1890 |  |
| <b>c (mm)</b> | 400 - 500 | 600  | 700  | 800  |  |

## EG30

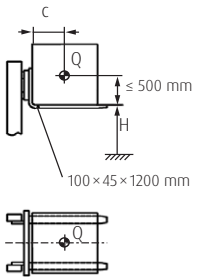

| H (mm)        | Q (kg)    |      |      |       |  |
|---------------|-----------|------|------|-------|--|
| 6000          | 2460      | 2220 | 2030 | 1860  |  |
| 5900          | 2520      | 2280 | 2080 | 1920  |  |
| 5800          | 2590      | 2340 | 2140 | 1970  |  |
| 5700          | 2660      | 2400 | 2190 | 2020  |  |
| 5600          | 2730      | 2470 | 2250 | 20700 |  |
| 5500          | 2790      | 2530 | 2310 | 2120  |  |
| 5400          | 2860      | 2590 | 2360 | 2170  |  |
| 5300          | 2930      | 2650 | 2420 | 2220  |  |
| ≤ 5200        | 3000      | 2710 | 2470 | 2280  |  |
| <b>c (mm)</b> | 400 - 500 | 600  | 700  | 800   |  |

## EG30 H

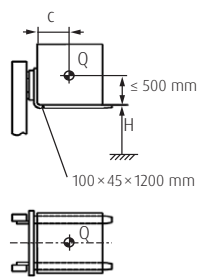

| H (mm)        | Q (kg)    |      |      |       |  |
|---------------|-----------|------|------|-------|--|
| 6000          | 2460      | 2220 | 2030 | 1860  |  |
| 5900          | 2520      | 2280 | 2080 | 1920  |  |
| 5800          | 2590      | 2340 | 2140 | 1970  |  |
| 5700          | 2660      | 2400 | 2190 | 2020  |  |
| 5600          | 2730      | 2470 | 2250 | 20700 |  |
| 5500          | 2790      | 2530 | 2310 | 2120  |  |
| 5400          | 2860      | 2590 | 2360 | 2170  |  |
| 5300          | 2930      | 2650 | 2420 | 2220  |  |
| ≤ 5200        | 3000      | 2710 | 2470 | 2280  |  |
| <b>c (mm)</b> | 400 - 500 | 600  | 700  | 800   |  |

## EG35 H

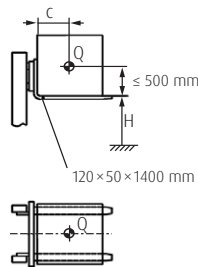

| H (mm)        | Q (kg)    |      |      |      |  |
|---------------|-----------|------|------|------|--|
| 6000          | 2880      | 2600 | 2380 | 2190 |  |
| 5900          | 2960      | 2680 | 2450 | 2250 |  |
| 5800          | 3050      | 2760 | 2520 | 2320 |  |
| 5700          | 3140      | 2840 | 2600 | 2390 |  |
| 5600          | 3230      | 2920 | 2670 | 2460 |  |
| 5500          | 3320      | 3000 | 2740 | 2520 |  |
| 5400          | 3410      | 3080 | 2820 | 2590 |  |
| ≤ 5300        | 3500      | 3160 | 2890 | 2660 |  |
| <b>c (mm)</b> | 400 - 500 | 600  | 700  | 800  |  |

H = Lifting height, c = Load centre, Q = Load capacity  
Load capacity for standard mast and fork carriage

# STANDARD AND OPTIONAL EQUIPMENT

| Manufacturer's type designation/Equipment |                                                                                                                    | EG25 - EG35 |
|-------------------------------------------|--------------------------------------------------------------------------------------------------------------------|-------------|
| Safety                                    | Linde Curve Assist - automatic driving speed reduction when cornering                                              | ●           |
|                                           | Electrical seatbelt monitoring - visual and acoustic feedback                                                      | ●           |
|                                           | BlueSpot - optical warning signal for pedestrians and drivers                                                      | ○           |
|                                           | Speed limitations                                                                                                  | ○           |
|                                           | Flashing beacon                                                                                                    | ○           |
|                                           | Truck lighting: VertiLight                                                                                         | ○           |
| Digitalisation                            | Data transmission online                                                                                           | ○           |
|                                           | Data transmission Wifi                                                                                             | ○           |
|                                           | Linde connect:desk - local fleet management with different functional modules                                      | ○           |
|                                           | Access control via PIN or RFID                                                                                     | ○           |
|                                           | Usage analysis                                                                                                     | ○           |
|                                           | Crash detection                                                                                                    | ○           |
| Operation/<br>Load Handling               | Twin pedal control - stepless acceleration and fast reversing                                                      | ●           |
|                                           | Single pedal control - stepless acceleration                                                                       | ○           |
|                                           | Linde Load Control - central levers fully integrated in the armrest for precise control of all hydraulic functions | ●           |
|                                           | Individual lever system                                                                                            | ○           |
| Workplace                                 | Ergonomic and safe truck access thanks to low entry step and grab handle bar on A-pillar                           | ●           |
|                                           | Adjustable steering column tilt                                                                                    | ●           |
|                                           | Operator's seat - mechanical quick weight adjustment with electronic seatbelt monitoring                           | ●           |
|                                           | 3.5" multi-functional display                                                                                      | ●           |
|                                           | Additional seat options with heating and air suspension                                                            | ○           |
|                                           | All-weather cab with steel doors                                                                                   | ○           |
|                                           | Full cabin heating system                                                                                          | ○           |
|                                           | Mirrors                                                                                                            | ○           |
| Mast                                      | Low-mounted tilting cylinders                                                                                      | ●           |
|                                           | Tilt-angle sensor for smooth mast stop                                                                             | ○           |
| Attach-<br>ment/<br>Forks                 | Reinforced Linde forks - easily adjustable and long-lasting                                                        | ○           |
|                                           | Integrated sideshift with full lift capacity, roller-guided                                                        | ○           |
|                                           | Integrated fork positioner                                                                                         | ○           |
| Axles and<br>Tyres                        | Linde Pendulum Axle                                                                                                | ●           |
|                                           | Super Elastic (SE) tyres                                                                                           | ●           |
|                                           | Antistatic, non-marking tyres                                                                                      | ○           |
| Drive and Brake<br>System                 | Twin-motor front wheel drive                                                                                       | ●           |
|                                           | Maintenance-free AC motors                                                                                         | ●           |
|                                           | Power settings: efficiency, economy, performance                                                                   | ●           |
|                                           | Oil-immersed, multi-disc brakes acting on both front wheels                                                        | ●           |
|                                           | Automatic parking brake                                                                                            | ○           |

● Standard equipment      ○ Optional equipment

# CHARACTERISTICS



Driver's workplace

## Ergonomics

- Spacious operator's cab and ergonomic seat ensure fatigue-free working
- Optimum view of both the load and the surroundings
- Linde Load Control ensures safe and accurate load handling with maximum efficiency
- Adjustable steering column and various storage compartments



Linde Pendulum Axle

## Handling

- The twin-motor front-wheel drive ensures maximum traction
- Compact design facilitates manoeuvrability in confined areas
- Choice of lead-acid or lithium-ion battery
- Wireless access to driver data allows data analysis and connection to logistics, safety and fleet management systems



Clear mast view

## Safety

- Chassis, A-pillar and mast provide the driver with optimum visibility of the load and surroundings
- The truck's low centre of gravity increases operator's safety while driving
- Linde Curve Assist reduces speed according to the steering angle when cornering
- Optional automatic parking brake



Easy service access

## Service

- Easy access to main components
- Driver display shows all important truck information to the driver
- Easy and quick access to battery thanks to 180°-opening battery door and battery hood
- Longer service interval for hydraulic oil and hydraulic oil filter change of 3000 h or 3 years

Subject to modification in the interest of progress. Illustrations and technical details may include options and are not binding for actual constructions. All dimensions subject to usual tolerances.

Presented by:

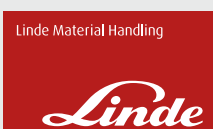
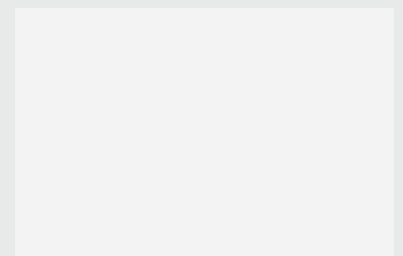

## Linde Material Handling GmbH

Carl-von-Linde-Platz | 63743 Aschaffenburg | Germany  
Phone + 49 6021 99 0 | Fax + 49 6021 99 1570  
www.linde-mh.com | info@linde-mh.com

Printed in Germany | DS\_EG25 - EG35\_1276-02\_en\_B\_1223